

DMX 512 Decoder Series

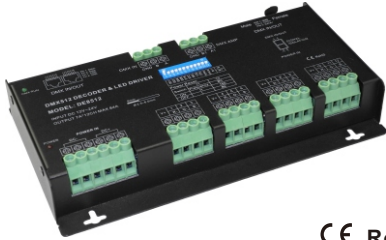

CE RoHS

Specifications

Model:	DE8512		
Input Voltage:	DC12-24V	Max output Power:	1008W(12V)/2016W(24V)
Max current Load:	7A*12CH Max 84A	Frequency:	500Hz/5000Hz
Control channels:	8CH	Signal Input:	DMX512/1990
Protection Grade:	IP20	DMX512/PWM Socket:	RJ45/XLR/Screw terminal
Gross Weight:	620g	Work Temp.:	-30°C~70°C

Basic Features

- Provide 3 - PIN XLR, green terminal and RJ45 DMX interface , among which the green terminal also has signal amplification function.
- Output 12 channels, MAX 7A per channel.Total current is 84A.
- 16 bit (65536 level) / 8 bit (256 level) gray level optional.
- Automatic protection and recovery function for short circuit and overload.

Dimensions

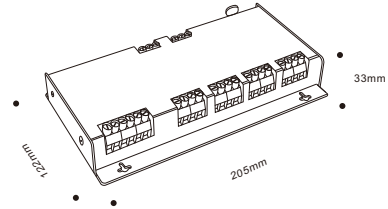

Component Diagram

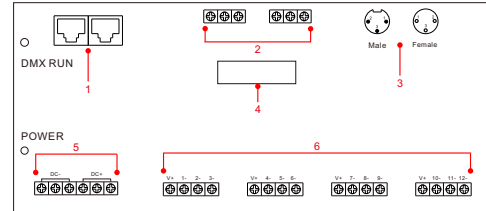

- 1.RJ45
- 2.Green Terminal (with amplifier function)
- 3.XLR-3 (or5-PIN option)
- 4.Address Dip Switch
- 5.Power Input Socket
- 6.LED lamps Connection Socket

*1,2,3 DMX input and output

Product Operation

Self-testing Mode:put all Dip-Switch NO.1 to NO.9 OFF
full channels output 3 seconds
then each color gradient.

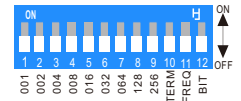

How to set DMX address via DIP switch:

DMX address value = the total value of (1-9) to get the place value when in "on" position otherwise will be 0.

E.g. 1 : Set Initial Address to 16.

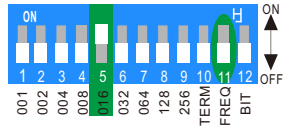

E.g. 2 : Set Initial Address to 20.

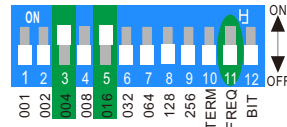

$$004+016=20$$

E.g. 3 : Set Initial Address to 149.

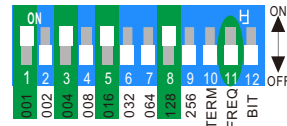

$$001+004+016+128=149$$

Dip-Switch NO. 10 is TERM for whole signal circle.
 Dip-Switch NO. 11 for Frequency option ON: 5000HZ(H) OFF: 500Hz(L)
 Dip-Switch NO. 12 for Bit option: ON: 16bit OFF: 8bit
 NO. 11 and NO. 12 change come into operation when Re-Power on.

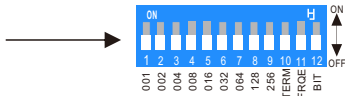

Wiring Diagram

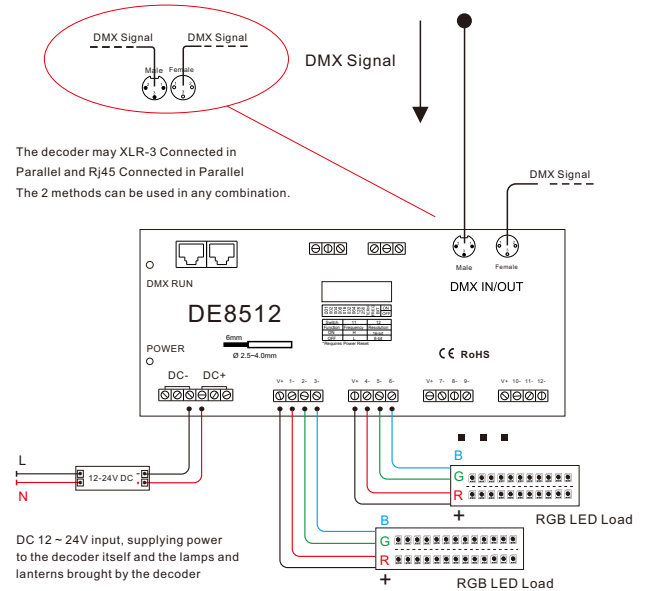

An amplifier is needed when more than 32 decoders are connected
 signal amplification should not be more than 4 times continuously
 DMX5000 output and DE8512's transmission lines can't be over 300 meters.

Suitable lamps and lanterns

